

## Features

- Premium construction ensures durability and reliability

## Recommended Products/Accessories

- K-14375 24" Double Towel Bar
- K-14377 Pivoting toilet paper holder
- K-14435 18" Towel Bar
- K-14436 24" Towel Bar
- K-14441 Towel Ring
- K-14443 Robe Hook
- K-14444 Vertical toilet paper holder



## Codes/Standards









ASME A112.18.1/CSA B125.1  
NOM Standards  
NOM 012-CONAGUA

## KOHLER® Faucet Lifetime Limited Warranty

See website for detailed warranty information.

## Available Colors/Finishes

*Color tiles intended for reference only.*

Color	Code	Description
	CP	Polished Chrome
	SN	Vibrant® Polished Nickel
	AF	Vibrant® French Gold
	BN	Vibrant® Brushed Nickel
	BV	Vibrant® Brushed Bronze
	BL	Matte Black
	2MB	Vibrant® Brushed Moderne Brass
	BGP	Vibrant Brushed Graphite
	TT	Vibrant Titanium

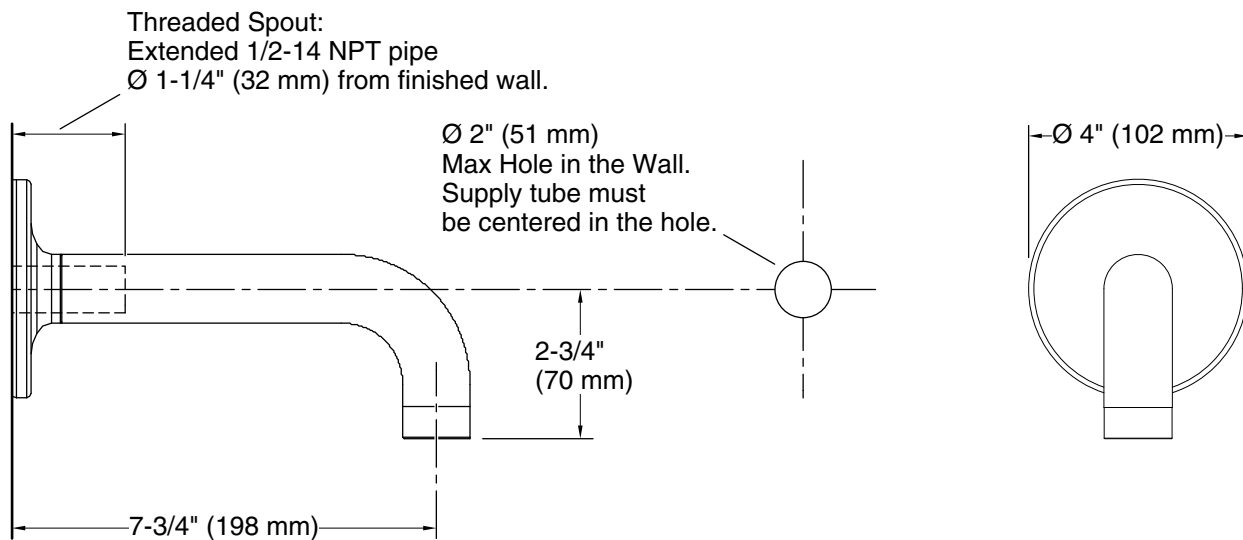

### Technical Information

All product dimensions are nominal.

#### Spout:

Spout reach: 7-3/4" (198 mm)

### Notes

Install this product according to the installation instructions.