

Features

- Single lever handle allows for both on/off activation and temperature setting
- Diverter switches water flow from bath fill to handshower, and returns to bath fill position when water is turned off
- 7 gpm (26.5 lpm) maximum flow rate at 45 psi
- 1.75 gpm (6.6 lpm) handshower flow rate
- KOHLER® ceramic disc valves exceed industry longevity standards for a lifetime of durable performance
- Coordinates with other products in the Purist collection

Material

- KOHLER finishes resist corrosion and tarnishing
- Premium metal construction for durability and reliability

Installation

- Floor-mount
- Compatibility with bathtub varies by application

Required Products/Accessories

K-97339 Mounting block for select floor-mount bath fillers

Recommended Products/Accessories

K-14375 24" Double Towel Bar
 K-14377 Pivoting toilet paper holder
 K-14435 18" Towel Bar
 K-14436 24" Towel Bar
 K-14441 Towel Ring
 K-14443 Robe Hook
 K-14444 Vertical toilet paper holder

Included Components

K-10257 Multifunction Handshower



Codes/Standards









ASME A112.18.1/CSA B125.1
 DOE - Energy Policy Act 1992
 EPA WaterSense®
 California Energy Commission (CEC)
 NOM Standards
 NOM 008-CONAGUA

KOHLER® Faucet Lifetime Limited Warranty

See website for detailed warranty information.

Available Colors/Finishes

Color tiles intended for reference only.

Color	Code	Description
	CP	Polished Chrome
	SN	Vibrant® Polished Nickel
	AF	Vibrant® French Gold
	BN	Vibrant® Brushed Nickel
	BV	Vibrant® Brushed Bronze
	BL	Matte Black
	2MB	Vibrant® Brushed Moderne Brass
	BGP	Vibrant Brushed Graphite
	TT	Vibrant Titanium

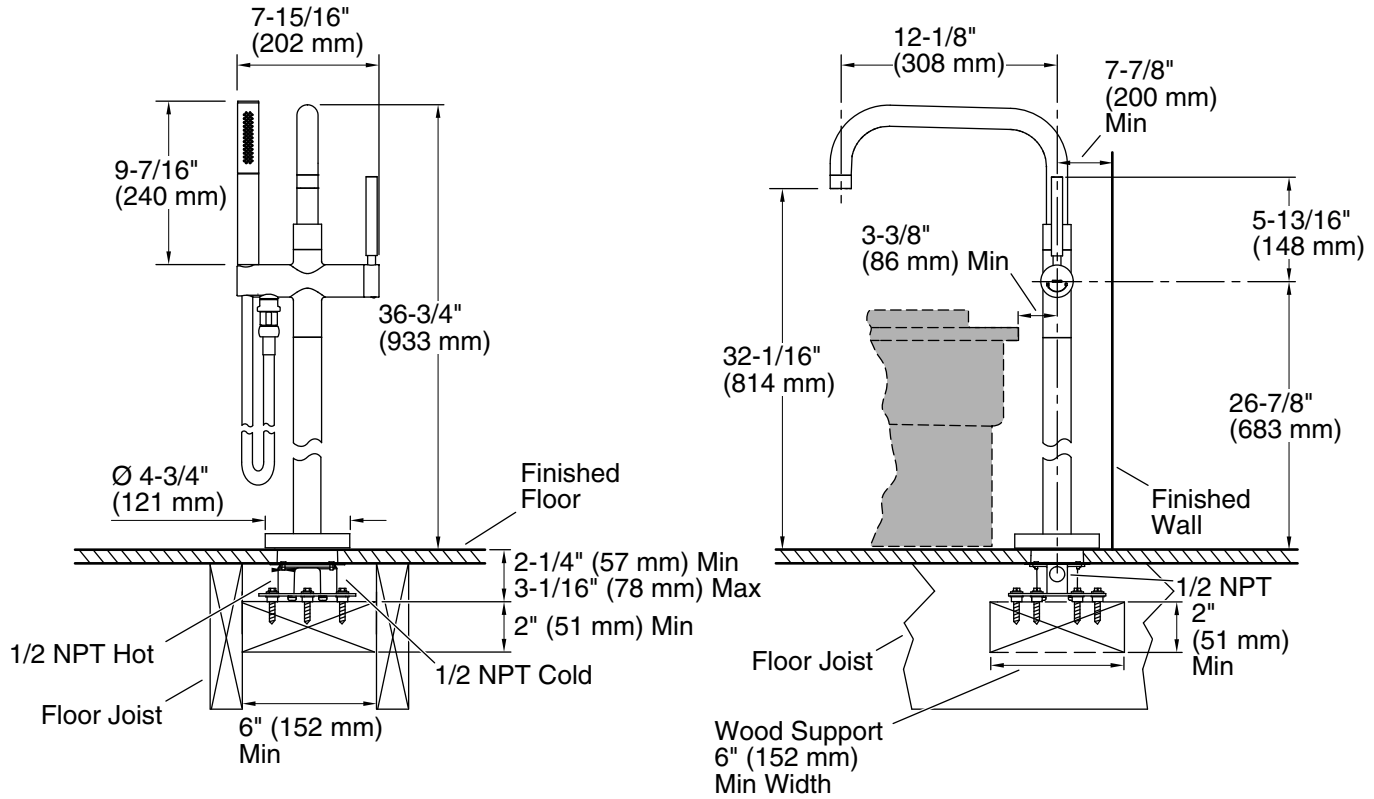

Technical Information

All product dimensions are nominal.

Faucet flow rate: 7 gal/min (26.5 l/min)

Spout:

Spout reach: 12-1/16" (306 mm)

Handshower rated max flow: 1.75 gal/min (6.6 l/min)

Notes

Install this product according to the installation guide.

Adequate floor support is required. The wood support must be a minimum of 2" (51 mm) thick by 6" (152 mm) wide. 2x6 lumber is NOT adequate for this application.

Concrete can be used as the floor support. Requires 3/16" masonry drill bit and six 1/4" x 1-3/4" concrete screws, not included.