

Features

- Two Lever handles offer separate control of hot and cold water
- 1.2 gpm (4.5 lpm) maximum flow rate at 60 psi (4.14 bar)
- KOHLER® ceramic disc valves exceed industry longevity standards for a lifetime of durable performance
- Metal pop-up drain with lift rod and 1-1/4" tailpiece
- Coordinates with other products in the Parallel collection

Material

- Premium metal construction for durability and reliability
- KOHLER finishes resist corrosion and tarnishing

Installation

- Three-hole installation for 8" - 16" centers
- Flexible supply lines and quick-connect fittings simplify installation

Recommended Products/Accessories

- K-23726 Drain treatment
- K-21897 Double toilet paper holder
- K-23524 18" towel bar
- K-23525 24" towel bar
- K-23526 Towel arm
- K-23527 Vertical toilet paper holder
- K-23528 Pivoting toilet paper holder
- K-23529 Robe hook



Codes/Standards







ASME A112.18.1/CSA B125.1
 NSF/ANSI/CAN 61
 NSF/ANSI/CAN 372
 DOE - Energy Policy Act 1992
 EPA WaterSense®
 California Energy Commission (CEC)
 ADA
 ICC/ANSI A117.1
 CSA B651
 OBC
 NOM Standards
 NOM 012-CONAGUA

KOHLER® Faucet Lifetime Limited Warranty

See website for detailed warranty information.

Available Colors/Finishes

Color tiles intended for reference only.

Color	Code	Description
	CP	Polished Chrome
	SN	Vibrant® Polished Nickel
	AF	Vibrant® French Gold
	BN	Vibrant® Brushed Nickel
	BV	Vibrant® Brushed Bronze
	BL	Matte Black

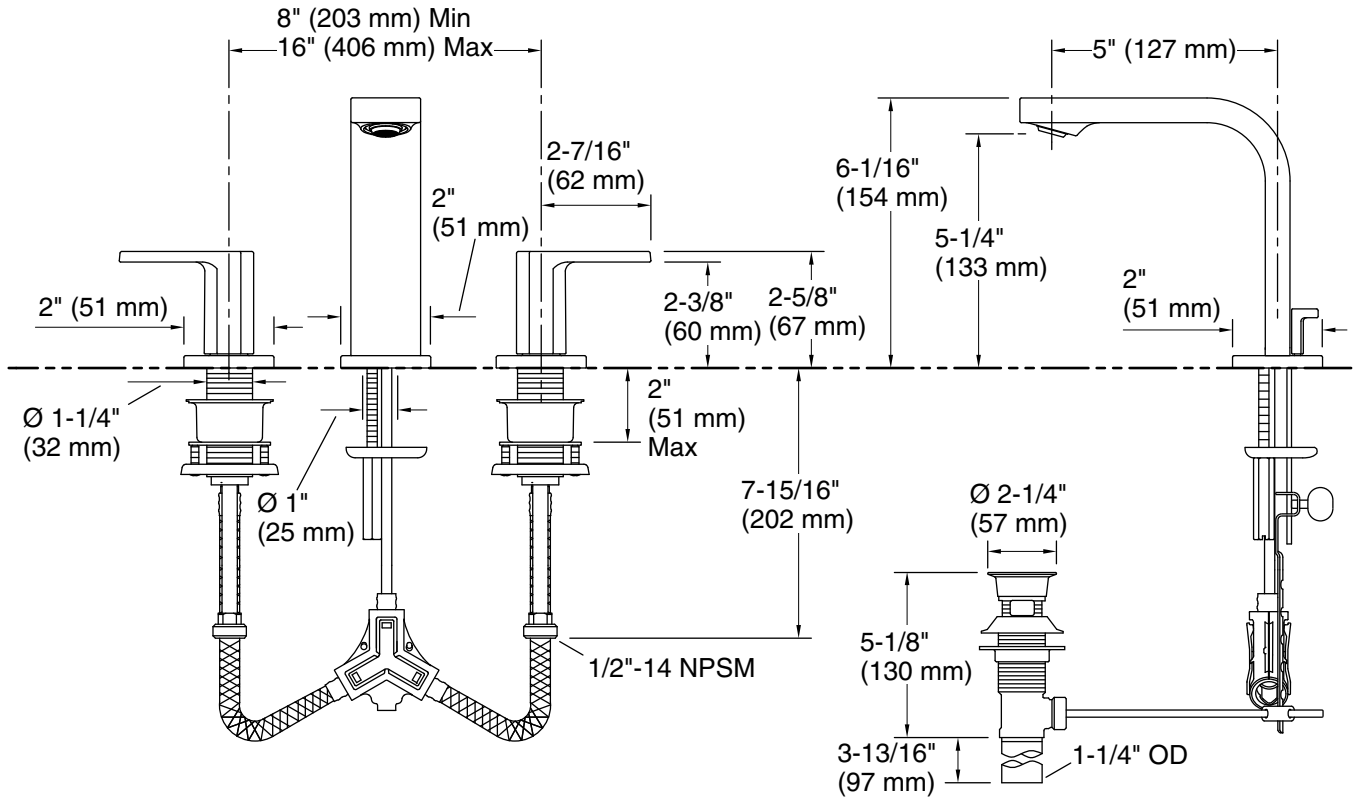

Technical Information

All product dimensions are nominal.

Faucet flow rate: 1.2 gal/min (4.5 l/min)

Drain included: Yes

Drain with overflow: Yes

Drain tailpiece included: Yes

Spout:

Spout reach: 5" (127 mm)

Notes

Install this product according to the installation instructions.

ADA compliant for handles only.

ADA, OBC, CSA B651 compliant when installed to the specific requirements of these regulations.