

Features

- Patented K-joint installation ensures consistent trim appearance, regardless of variability in valve rough-in
- Trim requires valve to complete
- KOHLER finishes resist corrosion and tarnishing, exceeding industry durability standards over two times

Required Products/Accessories

- K-2972-KS 1/2" Thermostatic Mixing Valve
or
K-2975-KS 3/4" Thermostatic Mixing Valve



ADA CSA B651 OBC

Codes/Standards







ASME A112.18.1/CSA B125.1
ADA
ICC/ANSI A117.1
CSA B651
OBC

KOHLER® Faucet Lifetime Limited Warranty

See website for detailed warranty information.

Available Colors/Finishes

Color tiles intended for reference only.

| Color | Code | Description |
|--|------|--------------------------|
|  | CP | Polished Chrome |
|  | SN | Vibrant® Polished Nickel |
|  | PB | Vibrant® Polished Brass |
|  | BN | Vibrant® Brushed Nickel |
|  | BV | Vibrant® Brushed Bronze |
|  | 2BZ | Oil-Rubbed Bronze |

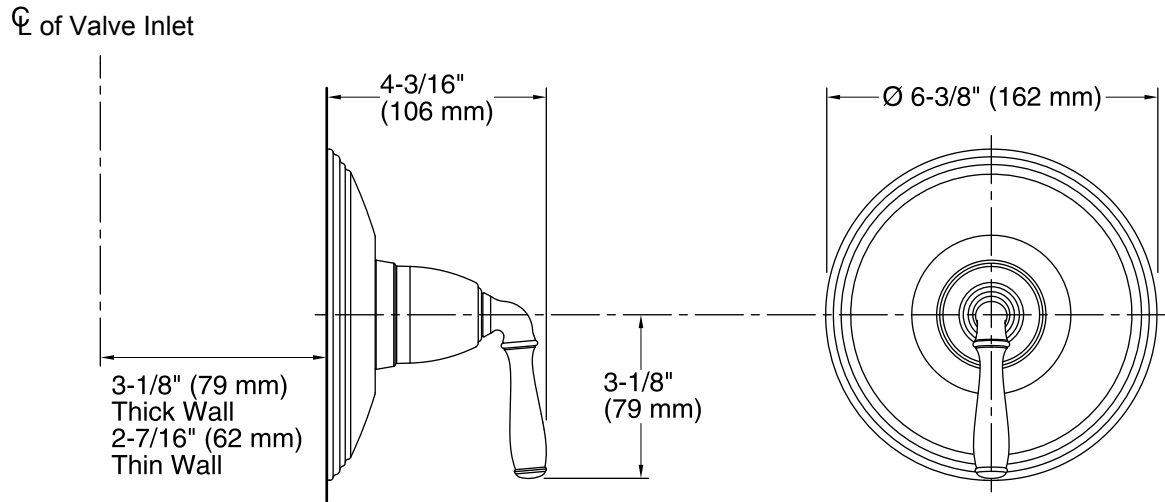

Technical Information

All product dimensions are nominal.

Notes

ADA, OBC, CSA B651 compliant when installed to the specific requirements of these regulations.