

Features

- Geometric oval basin with vertical sides
- Overflow drain
- No faucet holes; requires wall- or counter-mount faucet
- Fits standard 14" x 17" (356 x 432 mm) countertop cutout

Material

- Vitreous china

Installation

- Undermount

Recommended Products/Accessories

- K-8998 P-Trap
- K-23726 Drain treatment
- K-23725 Cast iron cleaner

Included Components

- 1193643 Basin clamps



ADA

Codes/Standards





ASME A112.19.2/CSA B45.1
ADA
ICC/ANSI A117.1

KOHLER® Vitreous China Bathroom Sink Lifetime Limited Warranty

See website for detailed warranty information.

Available Colors/Finishes

Color tiles intended for reference only.

Color	Code	Description
	0	White
	96	Biscuit
	NY	Dune
	95	Ice™ Grey
	7	Black Black™

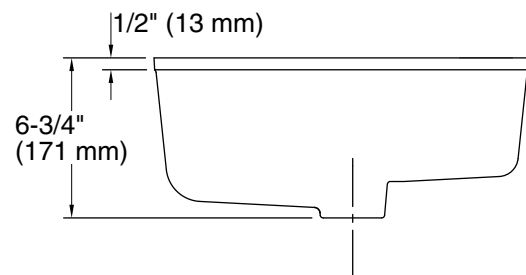
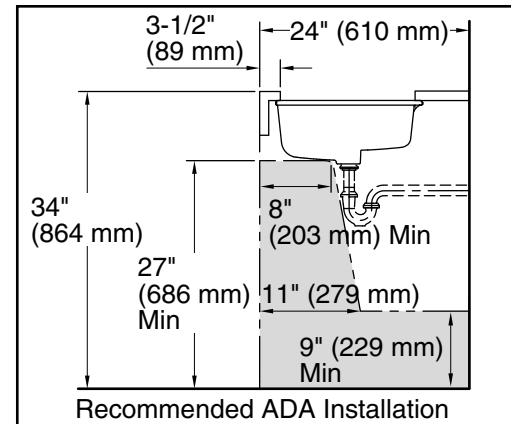
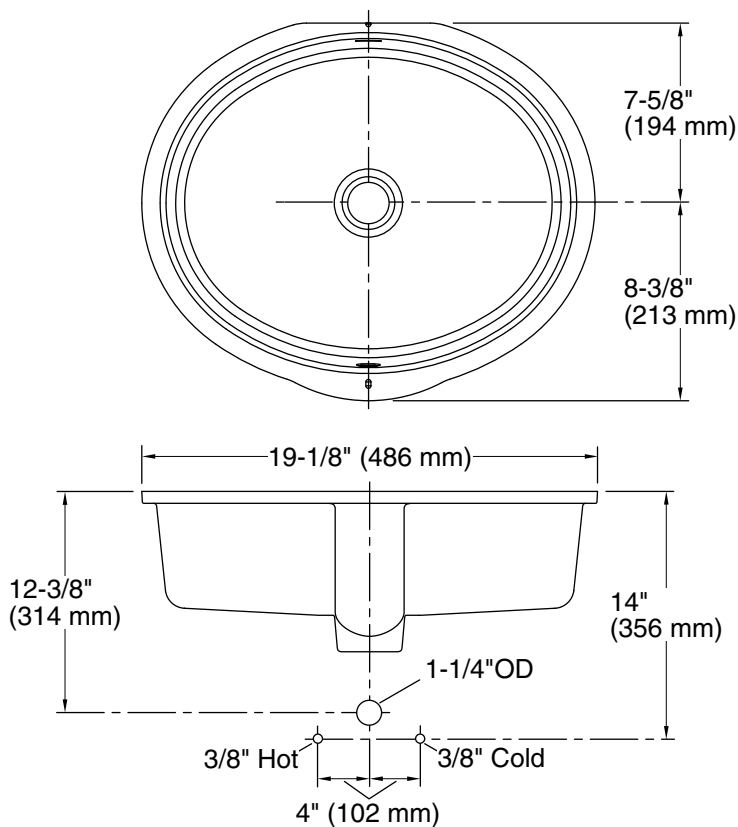

Technical Information

All product dimensions are nominal.

- Basin configuration: Single Bowl
- Bowl area (Only):
 - Length: 17" (432 mm)
 - Width: 14" (356 mm)
 - Water depth: 3-1/8" (79 mm)
- With overflow: Yes
- Drain hole: 1-3/4" (44 mm)
- Template: 1151011-7, required, not included

Notes

Install this product according to the installation instructions.

NOTICE: Countertop manufacturer or cutter must use the current product template available at www.kohler.com, or by calling 1-800-4KOHLER. Kohler Co. is not responsible for cutout errors when the incorrect cutout template is used.

Product dimensions are nominal and may vary per ASME A112.19.2 tolerances.

ADA compliant when installed to the specific requirements of these regulations.