

Features

- No internal linkages, reducing the chance of clogs in the overflow pipe
- Ball-joint construction for easy installation
- Includes toe-activated closing, PVC tee, and pipe
- For use with Elevance™, Archer™, Underscore®, Rêve™, and Parity™ baths and whirlpools

Material

- Schedule 40 PVC with metal overflow cover
- KOHLER finishes resist corrosion and tarnishing

Installation

- Above- or through-the-floor

Recommended Products/Accessories

- K-23726 Drain treatment
- K-7117 Slotted overflow pressure test seal kit



Codes/Standards











ASME A112.18.2/CSA B125.2

KOHLER® One-Year Limited Warranty

See website for detailed warranty information.

Available Colors/Finishes

Color tiles intended for reference only.

Color	Code	Description
	CP	Polished Chrome
	SN	Vibrant® Polished Nickel
	AF	Vibrant® French Gold
	BGD	Vibrant® Moderne Brushed Gold
	BN	Vibrant® Brushed Nickel
	BV	Vibrant® Brushed Bronze
	BL	Matte Black
	2MB	Vibrant® Brushed Moderne Brass
	TT	Vibrant Titanium
	BGP	Vibrant Brushed Graphite
	DR	Deep Bronze

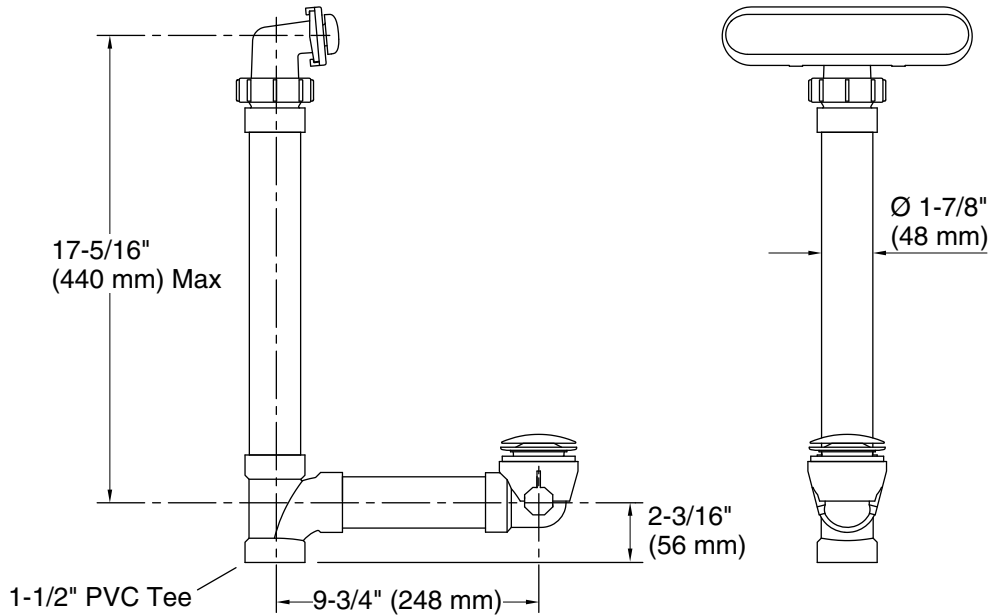

Technical Information

All product dimensions are nominal.

Material: Plastic