

Features

- 30" (762 mm) minimum base cabinet width
- Single bowl
- 9" (229 mm) depth provides generous workspace
- Five oversized faucet holes
- Bowl slopes toward drain to minimize water pooling
- Offset drain increases workspace in the sink and storage space underneath
- Includes K-6239 colander with integral cutting board and K-9137 bottom sink rack

Material

- KOHLER® enameled cast iron

Installation

- Undermount

Recommended Products/Accessories

- K-8801 Sink drain and strainer with tailpiece
- K-8799 Sink drain and strainer basket
- K-23726 Drain treatment
- K-23725 Cast iron cleaner
- 1411886 Undermount sink kit 23"

Optional Products/Accessories

- K-11352 Disposal Flange with Stopper
- K-9000 P-Trap

Included Components

- K-6239 Colander with Cutting Board
- K-9137 Sink rack



Codes/Standards







ASME A112.19.1/CSA B45.2

KOHLER® Enameled Cast Iron Kitchen and Bathroom Sink Lifetime Limited Warranty

See website for detailed warranty information.

Available Colors/Finishes

Color tiles intended for reference only.

| Color | Code | Description |
|---|------|--------------|
|  | 0 | White |
|  | FF | Sea Salt™ |
|  | 96 | Biscuit |
|  | NY | Dune |
|  | 95 | Ice™ Grey |
|  | 7 | Black Black™ |
|  | TRF | Truffle |

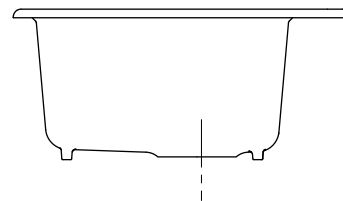
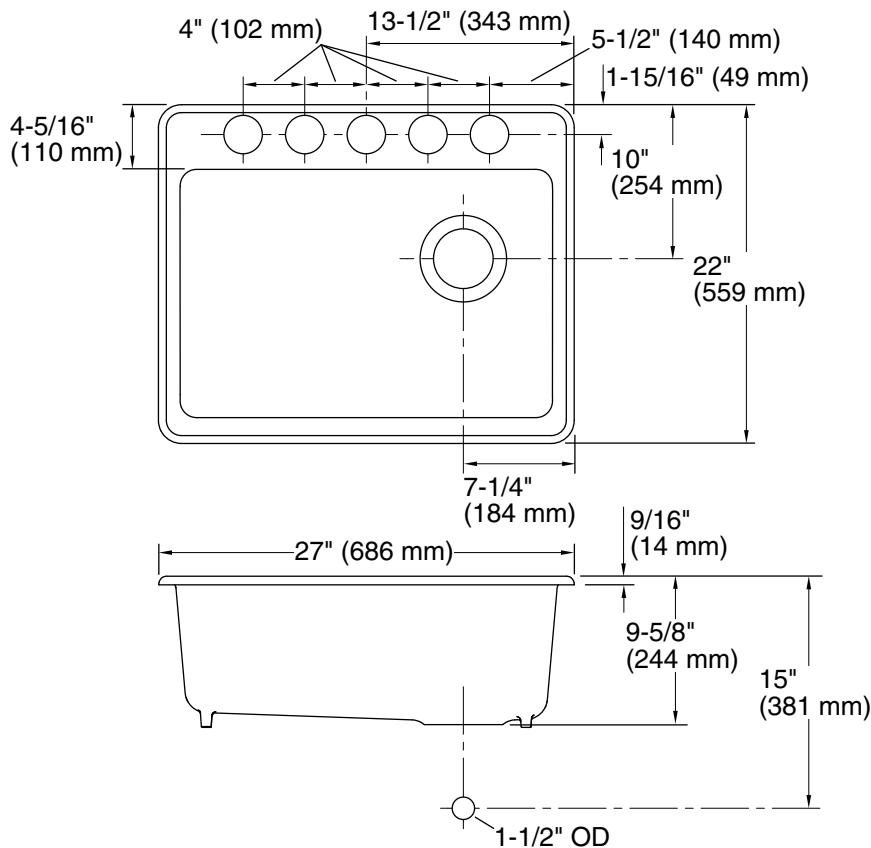

Technical Information

All product dimensions are nominal.

Basin configuration: Single Bowl
Center(s): 8" (203 mm)
Min. base cabinet width: 30" (762 mm)

Bowl area (Basin #1): Length: 24-1/4" (616 mm)
Width: 15-13/16" (402 mm)
Bowl depth: 9" (229 mm)
Water depth: 9" (229 mm)

Number of deck holes: 5

Drain hole: 3-7/8" (98 mm)

Template: 1244382-7, required, included

Notes

Install this product according to the installation instructions.